



Product Data Sheet

# M6 Large Eye Eye Bolt



A Steel Large Eye - Eye Bolt	
Part Nos	T42502
Thread	M6
Material	C15E
Finish	BZP
WLL	70Kg
Conforms to	DIN 580

Dimensions in mm

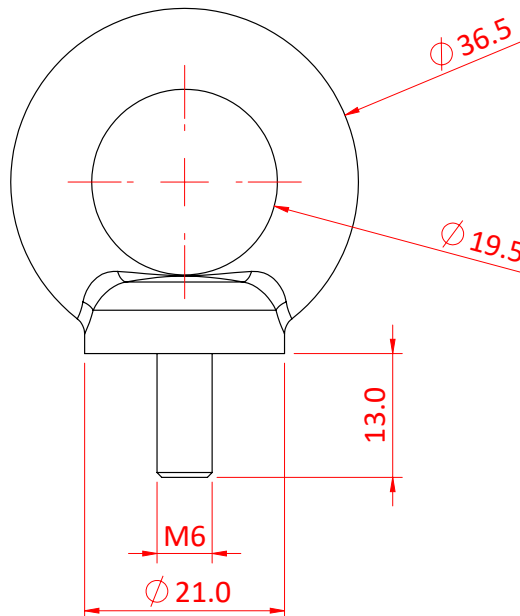

DIMENSIONS ARE A GUIDE ONLY AND MAY VARY